



Quick Setup Guide AHD Series

Identify Your Model

AHD SERIES LITE
 Modelo: L-D441-1T ✓
 L-D842M-ND ✓ L-DX841M-ND ✓

PRODUCT CONTENTS

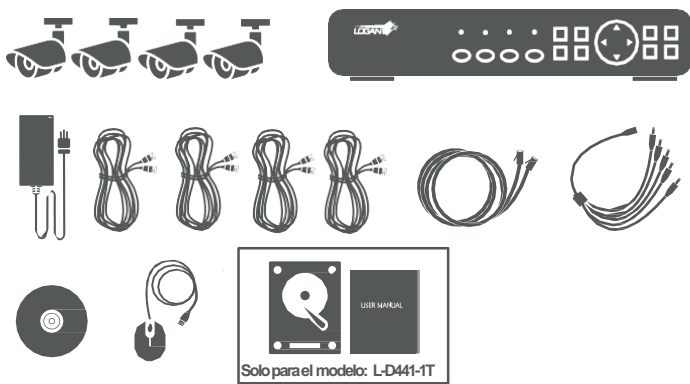

HOW TO CONNECT

Step 1: Connect the DVR to your MONITOR or TV

Connect a VGA or HDMI cord (not included) from your monitor or TV to the Output Port in the back of the DVR. Turn on your monitor or TV and select the appropriate input.

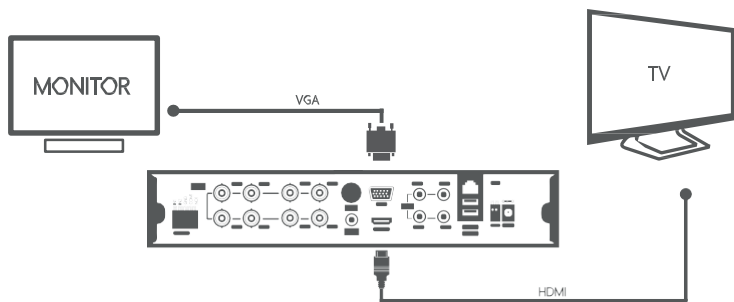

Step 2: Connecting the Cameras, Ethernet Cable and DVR

- Connect the USB cable to the bottom USB slot on the back.
- Connect the Ethernet cable to the back of the DVR.

- Connect the other end of the cable directly to your router or high speed connection input.
- Connecting the BNC & Power from camera with BNC power cable using the side labeled "To Camera Side Only".
- Using the other side of BNC power cable labeled "To DVR Side Only", connect BNC to BNC video input on DVR.
- Connect camera power cable to one of the multi power splitter ends.
- Connect DVR power cable to the multi power splitter end labeled "DVR POWER"
- Connect DVR power supply to DVR
 Plug DVR power supply into wall outlet

Note: Make sure all cameras and cables are properly connected prior to powering on the system.

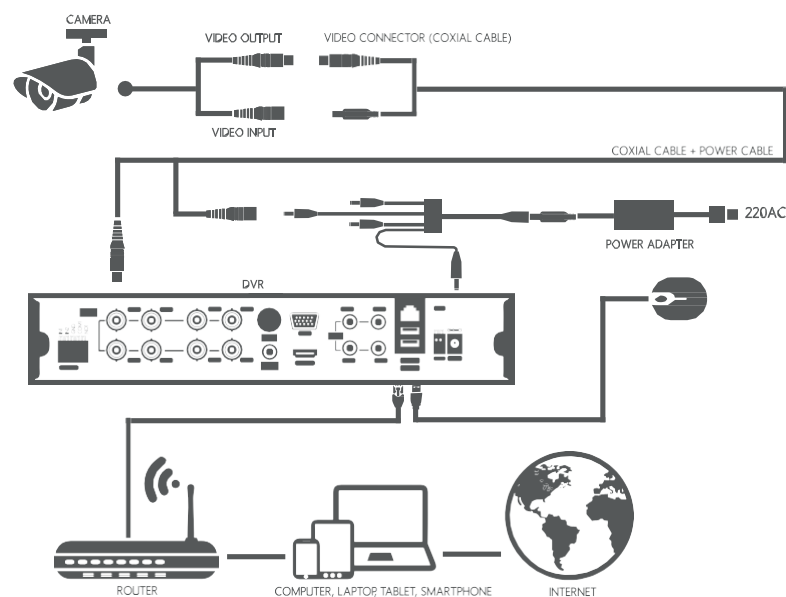

INSTANT MOBILE VIEWING
 EASY SETUP

1 Press <Next> on the Welcome Page.

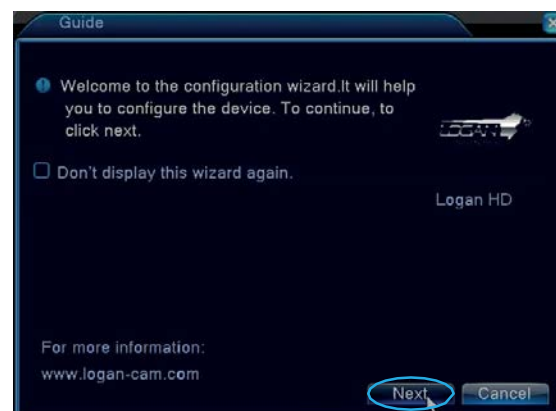

2 Log in with user name (default: admin) and password (default: leave it blank), to continue press OK.



3 Set up time and date according to the time zone of your country, to continue press Next.

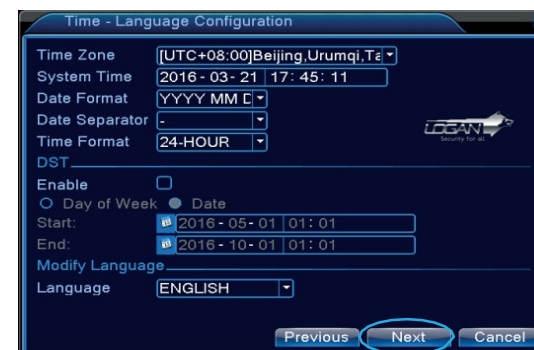

4 DVR is going to make sure you are connected into the internet, press Next to continue.

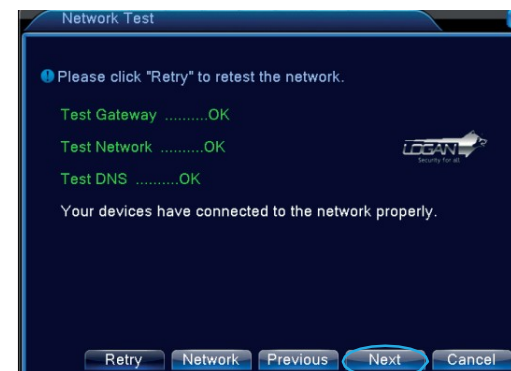

5 If you get an error just click the Network button below and follow the next step.

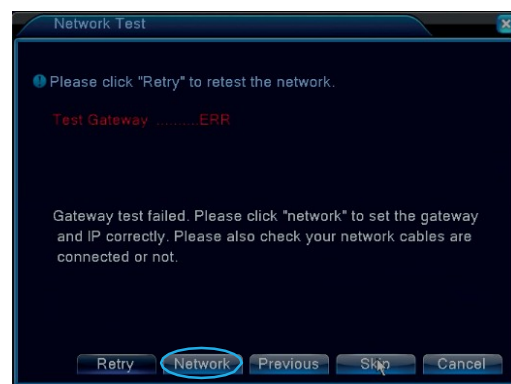

6 Make sure DHCP option is selected then press OK to continue.

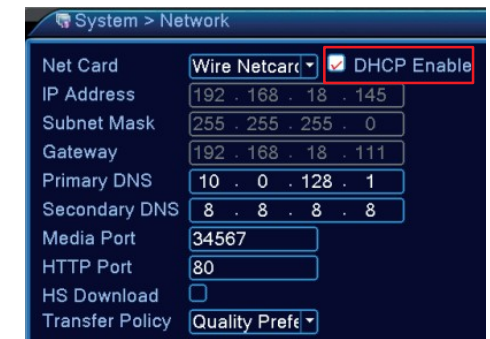

PROCEED TO DOWNLOAD THE APP
 ON YOUR SMARTPHONE AND ADD
 YOUR DEVICE

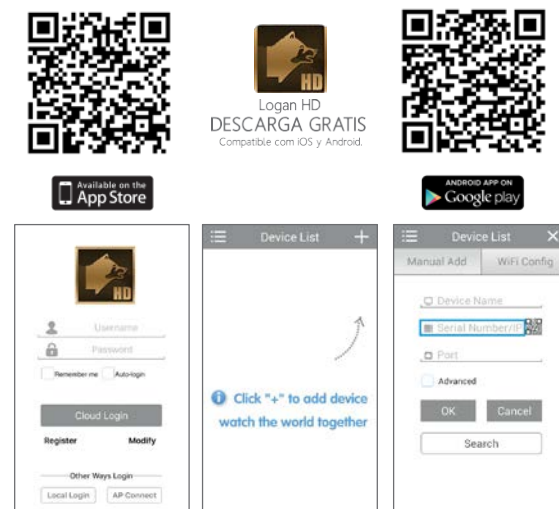

Add the DVR with the Serial number that is located later on this setup Guide or Follow the next step.

- 1 Scan QR code
- 2 Serial number



Congratulations! You can now connect over the internet to view and playback videos on your Smartphone.

Need Help? Visit www.logan-cam.com or contact our technical Support team at Support@logan-cam.com